

PETKIT

USER MANUAL

PETKIT PURAX SELF-CLEANING CAT LITTER BOX

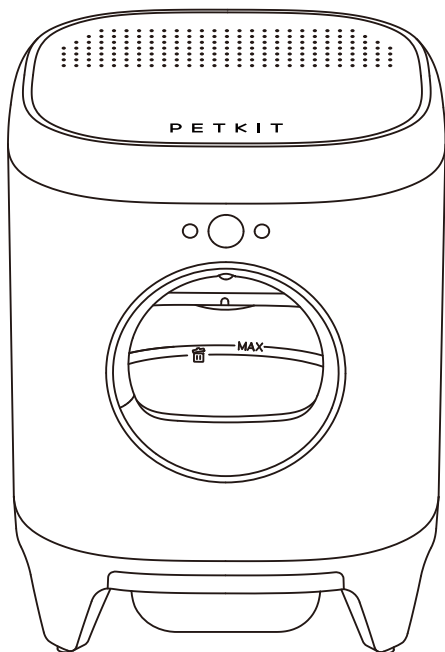

Please read the User Manual carefully before using the product and keep it properly.

V1.0-2023.06

TABLE OF CONTENTS

Product List	3
Product Description	4
Product Installation	6
How to Use	10
Cleaning and Maintenance	15
Video Guide	19
FAQ	20
Basic Specifications	21
A Message to Our Valued Customers	21
User Safety Guide	22

01 PRODUCT LIST

*Please ensure that all accessories are present before installation and use.

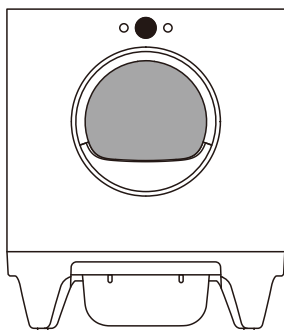

Main Unit

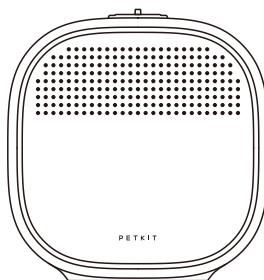

Lid

Accessories

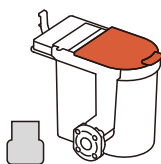

Deodorization
Module

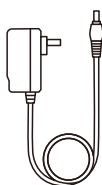

Power
Adapter



Concentrated
Purifying Liquid



Trash Bag

02 PRODUCT DESCRIPTION

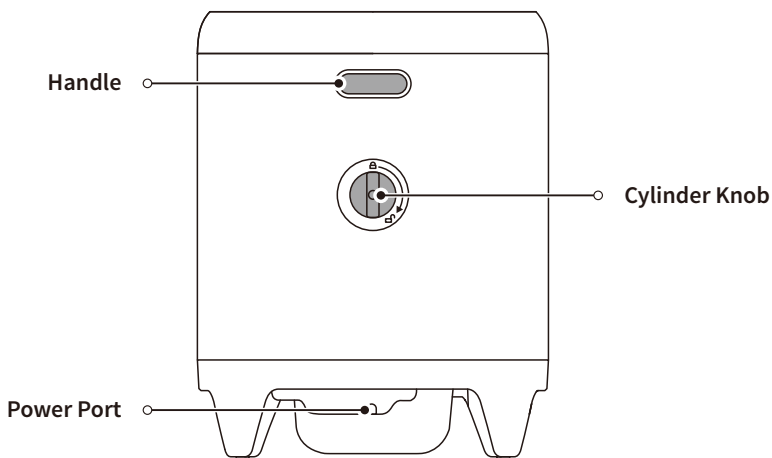
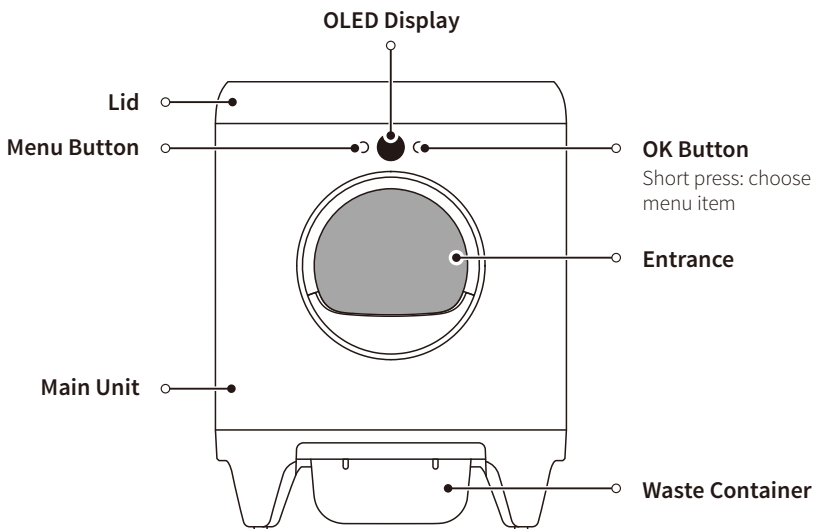

*Note: In order to enhance the user experience, periodic product improvements may be implemented. The product images shown are for illustrative purposes only. The actual product may vary from the image displayed on the packaging. For any inconsistencies, please refer to the actual product.

Top view of the main unit interior

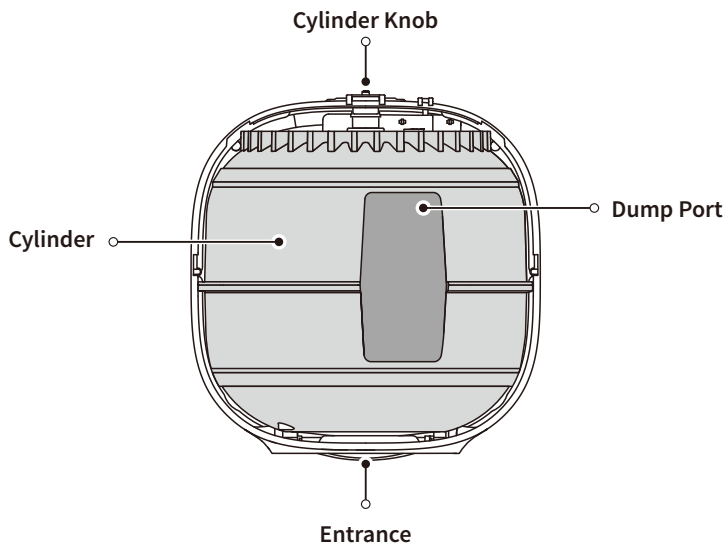

Top view of the main unit interior (After removing the cylinder)

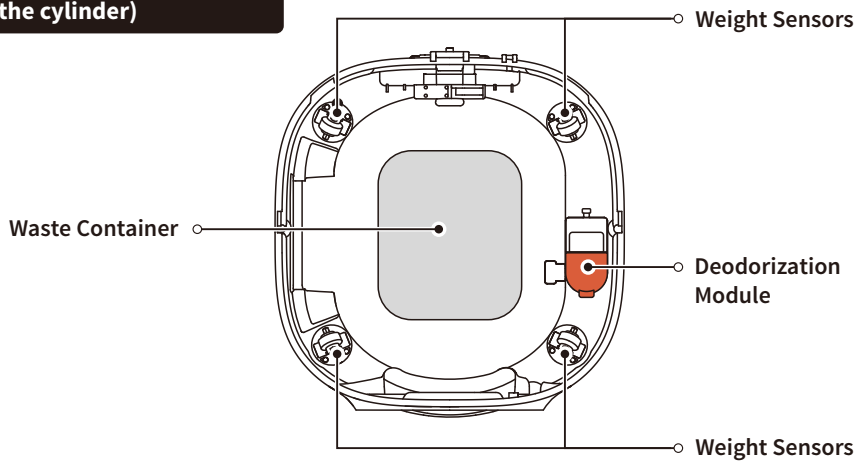

03 PRODUCT INSTALLATION

3.1 Installing Deodorization Module

① Turn the cylinder knob clockwise on the back of the main unit to unlock it.

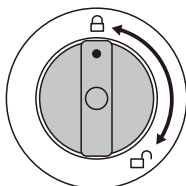
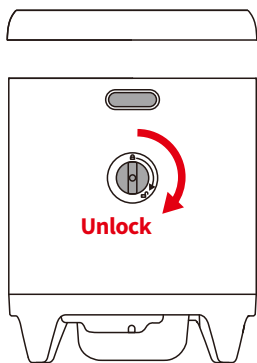

Cylinder Knob

② Hold the dump port with your hands and lift the cylinder upward.

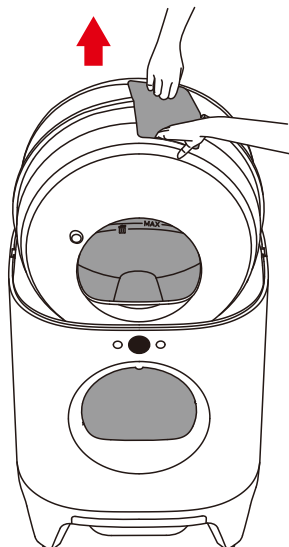

③ Open the soft rubber cover of the deodorization module and pour PETKIT purifying liquid (50ml) into it.

* Note: When the app reminds you that there is insufficient liquid, pour in an entire bottle of PETKIT purifying liquid. Ensure that the liquid does not exceed the MAX line.

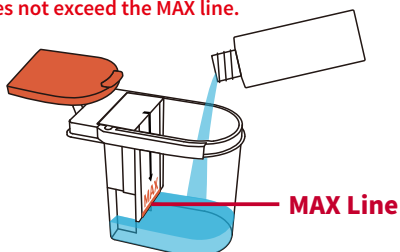

④ Cover the soft rubber cover and press it tightly to prevent the liquid from evaporating.

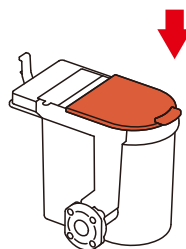

⚠ Please only use authentic PETKIT purifying liquid to prevent potential malfunctions caused by other deodorant liquids.

⑤ Put the deodorization module into the main unit. Once you hear a "Click," it is properly installed. Then, cover it with the dust-proof cover.

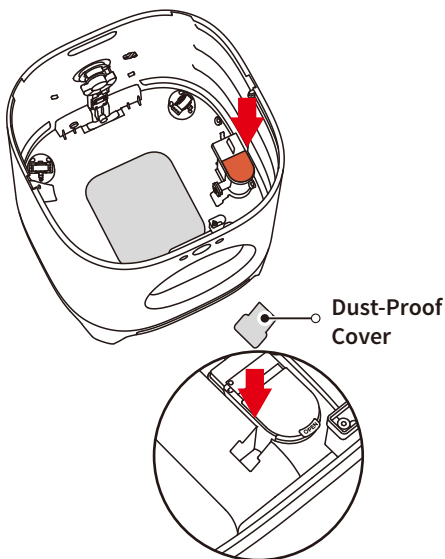

⑥ Hold the dump port with both hands and put the cylinder into the main unit.

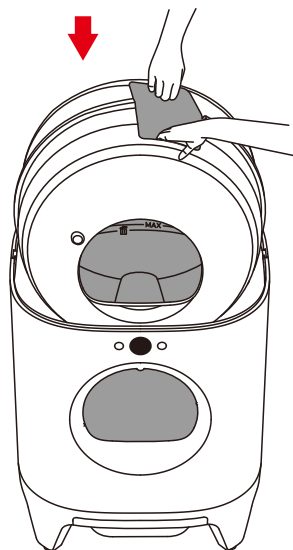

3.2 Pouring Cat Litter

Pour the cat litter through the dump port.

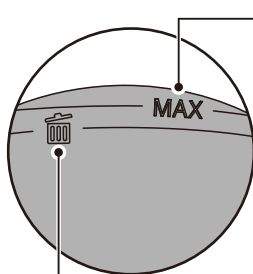

Litter MAX line

* Ensure that the amount of cat litter does not exceed the MAX line.

"Emptying Litter" line

When the remaining amount of cat litter is below this line , you can use the "Emptying Litter" function to remove the remaining litter from the cylinder at once.

* Note: Before emptying the litter, please ensure that there is enough space in the waste container; Do not allow cats to enter the cylinder during the emptying process to avoid interrupting the operation; Do not disconnect the power during the emptying process.

3.3 Covering Lid of Main Unit

- ① Turn the cylinder knob counterclockwise on the back of the main unit, and make sure the cylinder is fixed.
- ② Cover the lid of the main unit.

* Note: The "PETKIT" logo should be positioned above the entrance of the main unit.

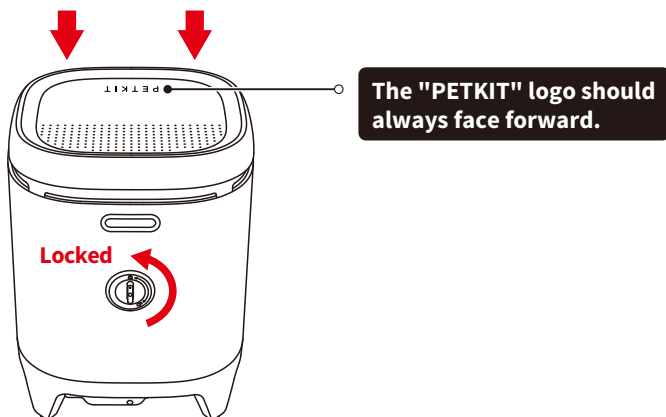

3.4 Installing Trash Bag

- ① Pull out the waste container and remove the trash bag ring.

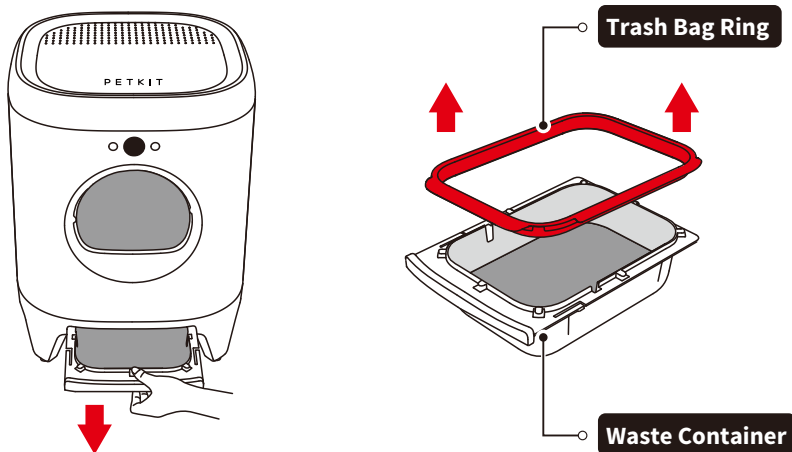

② Spread the trash bag evenly and fasten the four corners onto the four fixtures of the waste container.

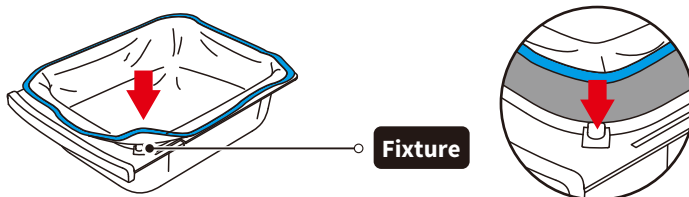

③ Put on the trash bag ring and press it tightly. Smooth the trash bag and put it back into the bottom of the main unit.

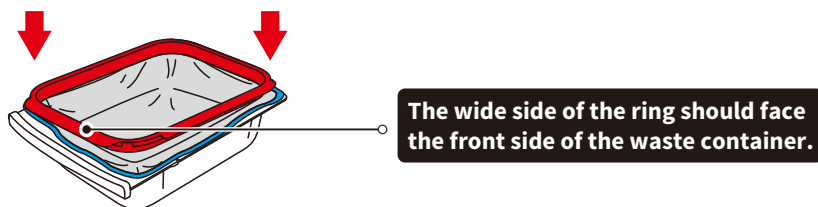

* Note: Please ensure that the trash bag is correctly positioned and that the edges of the bag are smooth. Incorrect placement may affect the sensing of the amount of cat litter in the waste container.

3.5 Plugging in

Take out the power adapter, insert it into the power port on the back of the main unit, and then insert the plug into the power socket.

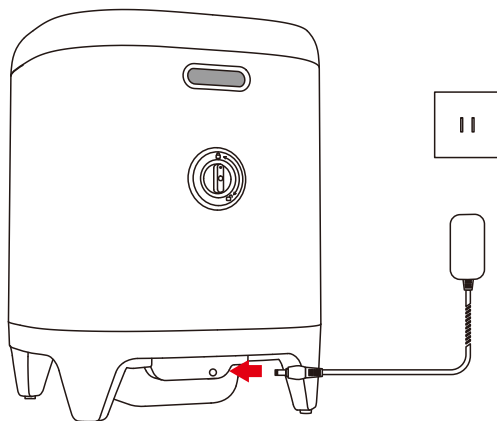



04 HOW TO USE

4.1 Operating Main Unit

Button usage



OLED display

- ⊙ Long press  : Turn on/Turn off
- ⊙ Short press  : Switch functions and the screen will display the selected function.
- ⊙ Short press  : Execute the selected function.

Function Description



Clean now

Begin self-cleaning



Deodorize now

Spray deodorization



Empty cat litter

Dump all litter to the waste container (use when cleaning the litter box)



Level cat litter

Evenly distribute litter (use after refilling litter)



Reset

Rotate cylinder back to original position

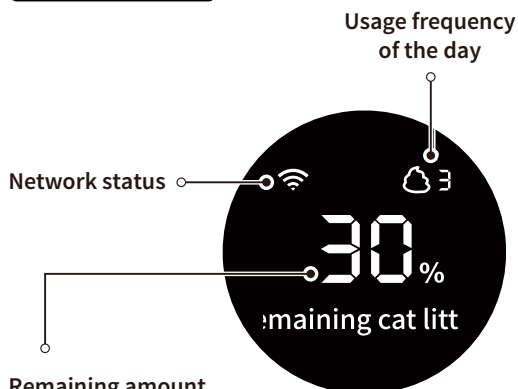

figure the netw

Connect to Wi-Fi (use when binding the litter box to the app)

4.2 Display Indication

Status Indication



Remaining amount of cat litter

Please record the type of litter in the app. As the density of different cat litters may vary, the displayed remaining amount of cat litter may vary slightly.

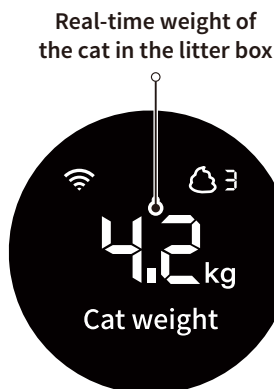

Fault Indication



Please check the direction of the lid and ensure it is in the correct position.



Please turn the cylinder knob on the back of the main unit to the locked position.



The device will automatically pause and remind when the pet approaches or enters the litter box during operation.



Check detailed fault information in the app.

4.3 App Control

① Download and install the app:

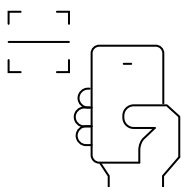

Download the PETKIT App from App Store or Android Stores



② Add the device

Open the PETKIT App and navigate to the home page. Tap the "+" button in the top right corner to add the device. Select "PETKIT PURAX SELF-CLEANING CAT LITTER BOX".



* Note: To enhance the user experience, occasional firmware upgrades may occur. The app interface may vary based on the actual situation. Please ensure that you update the firmware version in the app promptly.

③ Start the connection

Tap the device menu and switch to "Configure the network". Tap the OK button to initiate the connection. The screen will display "Connecting...". The app will start connecting to the device. Please wait until the configuration is successful.

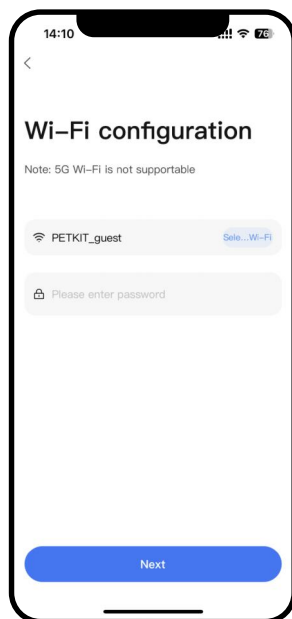
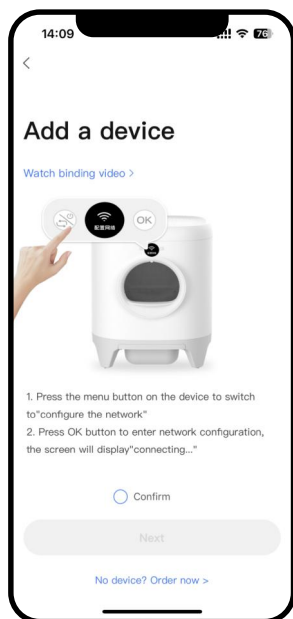

* Note: To enhance the user experience, occasional firmware upgrades may occur. The app interface may vary based on the actual situation. Please ensure that you update the firmware version in the app promptly.

④ Read replacement guide

To ensure the safety of your pet and the correct usage of this product, please carefully read the Replacement Guide. Use the product properly after successfully connecting the device for the first time.

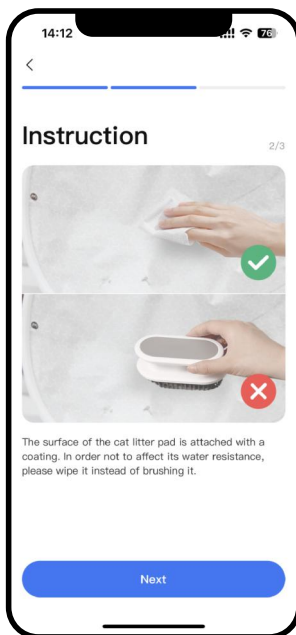
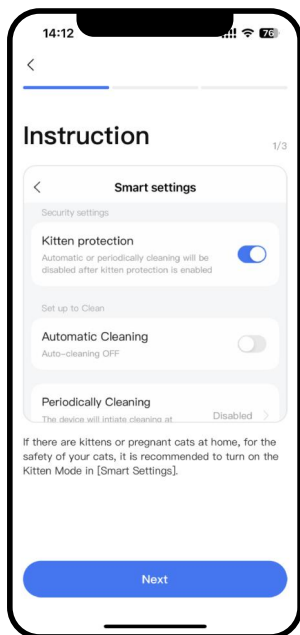

* Note: To enhance the user experience, occasional firmware upgrades may occur. The app interface may vary based on the actual situation. Please ensure that you update the firmware version in the app promptly.

05 CLEANING AND MAINTENANCE

To ensure the health of your cat, it is important to regularly disassemble and clean the cylinder.

5.1 Emptying Cat Litter

When the remaining amount of cat litter is below the specified line , you can use the "Emptying Litter" function to remove the remaining litter at once.

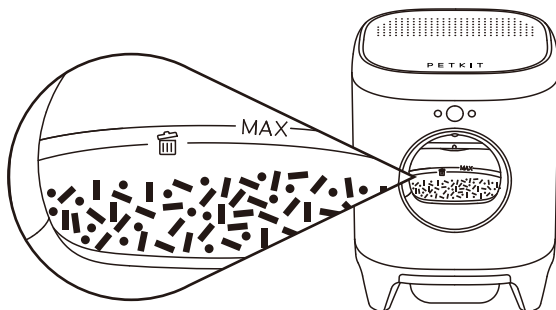

5.2 Disassembling Cylinder

First, remove the lid of the main unit. Then, turn the cylinder knob on the back of the main unit clockwise and lift the cylinder upward.

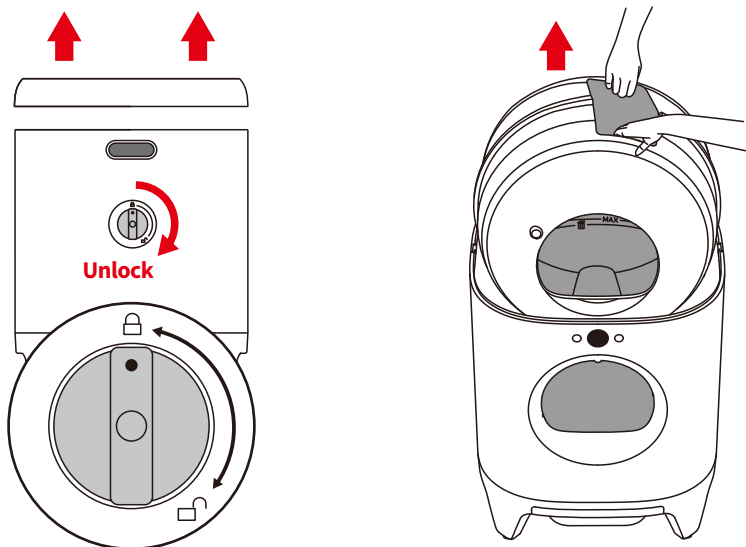

5.3 Disassembling Litter Sifter

① Grasp the litter sifter.

② Firmly press it.

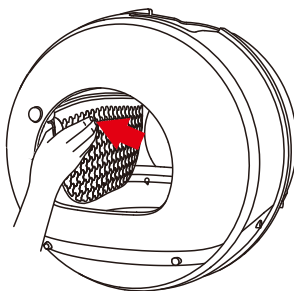
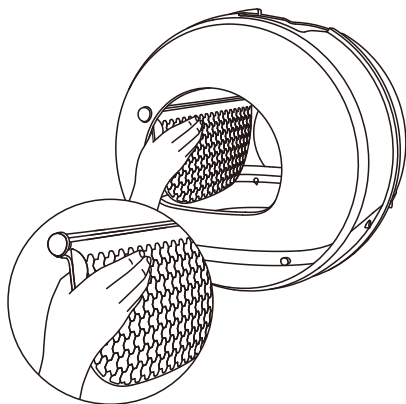

③ Make the litter sifter slightly bent.

④ Remove the left buckle of the litter sifter from the cylinder, and then pull out the entire litter sifter.

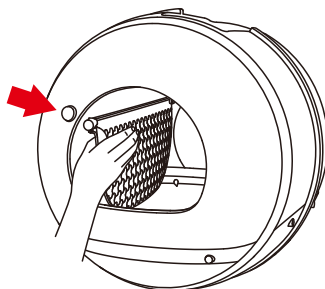
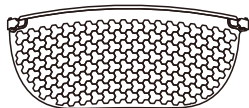
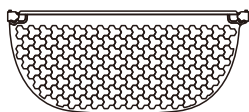

5.4 Cleaning Main Unit

- ① Wash the cylinder and litter sifter. It is recommended to add an appropriate amount of detergent and rinse them thoroughly.
- ② Use a wet towel to wipe the surface and interior of the main unit, ensuring that the sensors remain clean.

*** Note: After cleaning, all parts should be reassembled only when they are completely dry.**

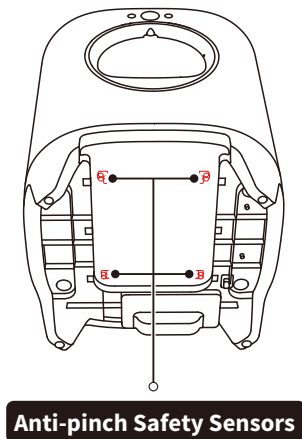
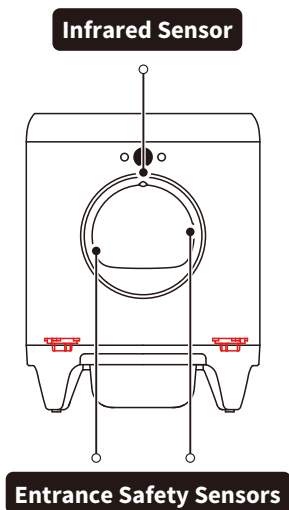

The main unit should only be wiped clean. It is prohibited to rinse or immerse it in water as it may cause damage to the product!

5.5 Installing Litter Sifter

① Secure the front side of the litter sifter into point A.

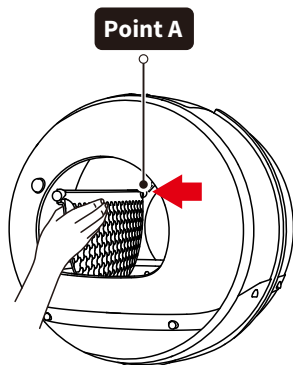

② Grasp the litter sifter and press it until it is slightly bent.

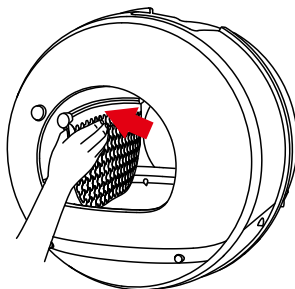

③ Secure the other side of the litter sifter into point B.

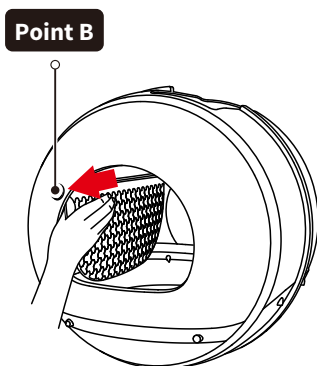

④ If the litter screen can be shaken back and forth, the installation is complete.

5.6 Installing Cylinder

Grasp the dump port and put the cylinder into the main unit; After the cylinder is placed stably, turn the cylinder knob on the back of the main unit counterclockwise and put on the lid.

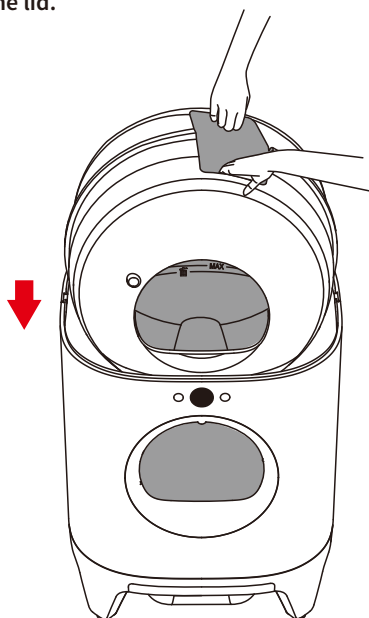

The "PETKIT" logo should
always face forward

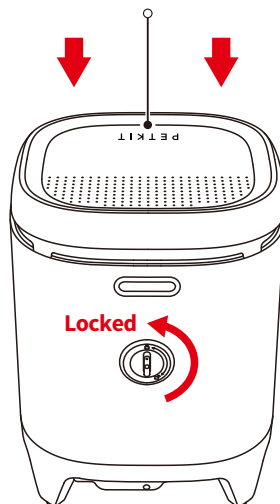

06 VIDEO GUIDE

6.1 Installation & Usage Video

Please copy the video URL and open it in your browser to view it.

<https://m.youtube.com/watch?v=74Ybb7CuZeA&feature=youtu.be>

6.2 Maintenance & Cleaning Video

Please copy the video URL and open it in your browser to view it.

<https://m.youtube.com/watch?v=ptcG5y6ynrE&feature=youtu.be>

07 FAQ

Q: Why does the cylinder rotate automatically when I put it into the machine without any operation?

A: The device automatically detects the position of the cylinder and restores it to the original position.

Q: Why does it show that the lid is not in place even though I have already placed it on the main unit properly?

A: Please ensure that the lid is correctly placed with the "PETKIT" logo facing the display.

Q: Why does the cylinder stop rotating during the working process?

A: During cylinder operation, the device activates comprehensive safety monitoring. It immediately stops running when a pet gets close or enters, and resumes automatically once the danger is cleared, with corresponding prompts on the display screen. The litter box entrance features an invisible safety fence that suspends operation when people approach.

Q: Why does the waste container display as full even though it is not full?

A: There are sensors on the top of the waste container to detect its fullness. Ensure that the trash bag is securely placed, press the trash bag ring firmly, and smooth the bag to prevent it from tilting and blocking the sensors, which could affect the detection.

Q: Why does the display screen turn off?

A: Under normal circumstances, when there is no operation for a certain period of time, the display screen enters the screen saver mode and shows the dynamic PETKIT logo. If the display screen is turned off in the App, it will appear as a black screen. Press any button to illuminate the screen. If the bright screen at night affects your rest, you can adjust the screen brightness settings.

Q: How do I use the App smart settings?

A: The smart settings for the cat litter box include Automatic Cleaning, Periodic Cleaning, and Periodic Deodorization. For households with fewer cats (less than 3), it is recommended to use Automatic Cleaning. For households with more cats (more than 3) or frequent use by cats, it is recommended to use Periodic Cleaning to avoid excessive cleaning. The device automatically deodorizes during the cleaning process, and Periodic Deodorization can be used based on your needs.

08 BASIC SPECIFICATIONS

Name	PETKIT PURAX SELF-CLEANING CAT LITTER BOX
Code	P9901
Dimensions	522*504*642mm
Weight	About 15kg (including adapter)
Rated Voltage	12V 
Rated Power	24W
Connection	Wi-Fi
Application	Cat

09 A MESSAGE TO OUR VALUED CUSTOMERS

- Thank you for choosing the PETKIT PURAX SELF-CLEANING CAT LITTER BOX.
- It is important to read and follow the User Manual before using the product. By using this product, you acknowledge that you have read and accepted the safety guidelines.
- PETKIT is not liable for any accidents or injuries resulting from improper use of the product.
- PETKIT reserves the rights of interpretation and revision.

10 USER SAFETY GUIDE

* Failure to follow the safety guides outlined below can result in product malfunction or other unforeseen mishaps.

- Please install and use the product as instructed in the User Manual.
- Pets under six months of age are not recommended to use this product.
- The product is for indoor use only. Avoid direct sunlight exposure and keep it away from open flames.
- Although the device uses low voltages, pets chewing on the power cord can cause electrical leakage. Please ensure proper guidance for your pets' use of the product.
- Use only the original adapter to avoid device damage or safety hazards.
- Place the device on a level surface to prevent purifying liquid leakage or equipment abnormalities.
- Do not immerse or soak the bottom of the main body of the product in water.
- If you are not using or moving the product for an extended period, it is recommended to unplug the power cord.
- Children should use this product under the supervision and guidance of adults.
- Repairs should only be performed by professionals to avoid safety hazards.
- Before leaving for an extended period, ensure that there is enough litter in the litter box and sufficient space in the waste container.
- If you encounter any issues with the product, please contact our customer service for assistance.